

Luxuria

BRAWNY
THE ELITE LUXURY SAFE



KAVAL[®]
SECURITY SYSTEMS & EQUIPMENT COMPANY



BRAWNY

THE ELITE LUXURY SAFE

BURGLARY & FIRE-RESISTANT LUXURY SAFE

BRAWNY is a Tested & Certified Heavy Safe.

DUAL PROTECTION:

Burglary Protection

- Certified by ECB·S in accordance with the European Standard, EN 14450, for burglary protection in S2.

Fire Protection

- Independently tested and certified by ECB·S according to European Standard EN 15659 as providing document fire resistance for up to 60 minutes.

CONSTRUCTION

- Body barrier thickness of 65mm; constructed from steel, welded throughout and filled with specially formulated Chubb safes barrier material.
- A solid composite 35mm thick door is combined with additional protection plates for crucial locking areas.
- Solid steel moving bolts with a 28.5mm diameter affix the door to the body, while fixed “anti-healing” bolts on both front and rear edges protect the door from prying attack.

LOCKING OPTIONS

- As the standard locking option, all models of Rhino MK II are fitted with a key lock and a combination lock.

KEYLOCK

- Secured by eight-lever double-bitted, non-key retaining key lock. ELECTRONIC LOCK
- A high security certified electronic locks can be fitted as second Lock.
- 1 master code, 1 supervisor code and 7 user codes.
- Time Delay: Up to 99 minutes before door unlocks.

Jewellery Safes



Our customized Luxury safes are designed with specialized interiors to prevent damage to delicate your valuable jewelry.

Soft linings, dedicated compartments, and watch winders ensure your items are stored safely.

Gun Safes

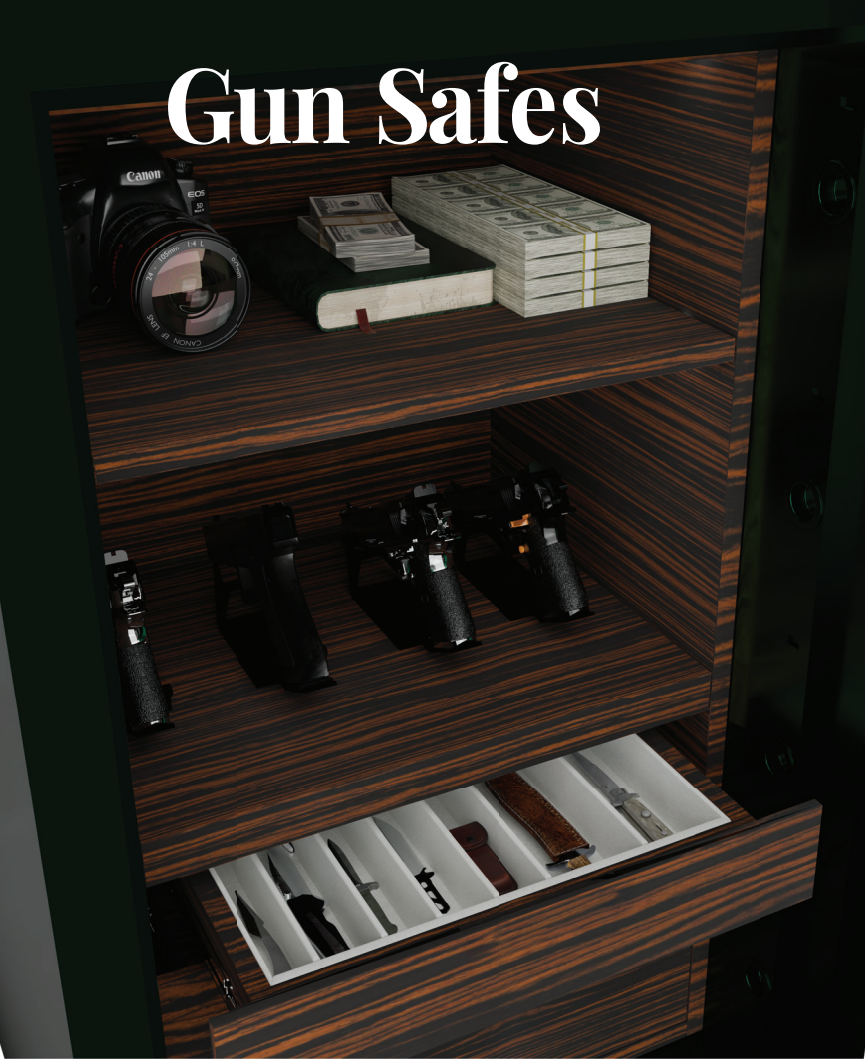

Secure your rifles, precious jewels, and valuable watches, all in a secure space of unmatched skill. Where fortification harmonizes with sophisticated living.

Watch Safes



Our luxury watch safes offer ultimate in security and sophistication, featuring precision German watch winders, soft-lined drawers, and dedicated compartments. Experience true peace of mind, knowing your collection is safeguarded in a secure, elegantly crafted environment.

HEISSE & SÖHNE

SEIT 1976

MADE IN GERMANY



Luxury Hand-Crafted Leather Safes

Transform your premium safe into a masterpiece of elegance with our custom leather wrapping. Each piece, expertly handcrafted, blends traditional artistry with modern flair. The meticulously selected leather enhances the safe's beauty, while its rich texture and flawless finish add a touch of distinction. Beyond mere security, your safe becomes as striking display of style and grandeur.

Our leather-clad safes, designed for those who value exquisite details, perfectly unite security with opulent design.



DRAWER OPTIONS

FOR LADIES



DL1 - PLAIN DRAWER

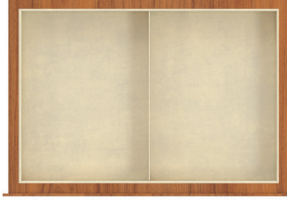

DL2 - 2 PARTITIONS



DL3 - RINGS AND PLAIN



DL4 - LONG CHAIN

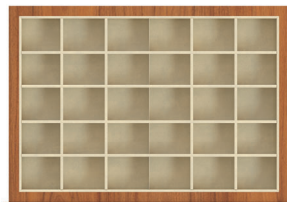

DL5 - EARRINGS



DL6 - EARRINGS



DL7 - RINGS AND EARRINGS



DL8 - BRACELETS



DL9 - BIG NECKLACE



DL10 - BANGLES



DL11 - WATCHES

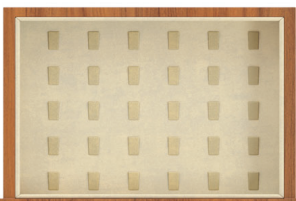

DL12 - RINGS



DL13 - NECKLACES

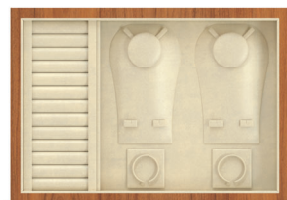

DL14 - RINGS AND LONG NECKLACES



DL15 - RINGS AND NECKLACES



DL16 - RINGS

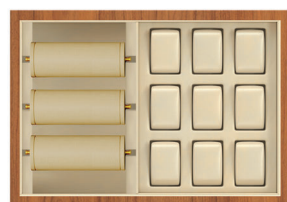

DL17 - BANGLES AND WATCHES

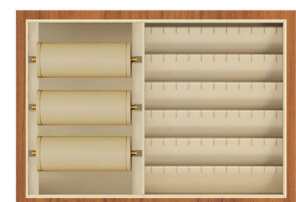

DL18 - BANGLES AND EARRINGS

DRAWER OPTIONS

FOR GENTS



DG1 - PLAIN DRAWER



DG2 - MISBAH

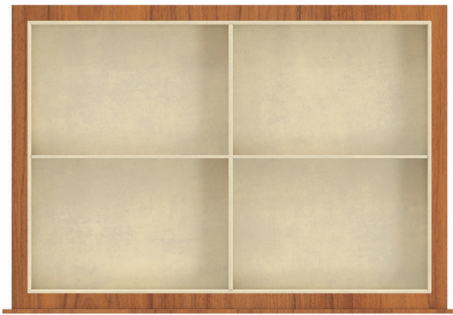

DG3 - 4 PARTITIONS

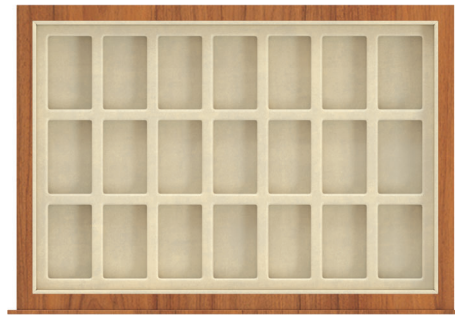

DG4 - LIGHTERS

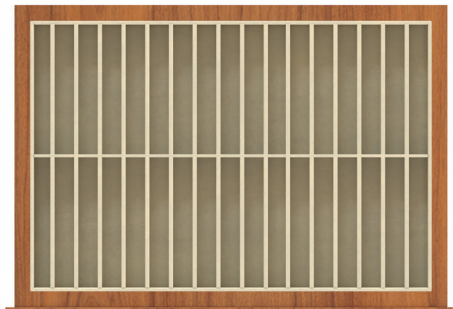

DG5 - PEN

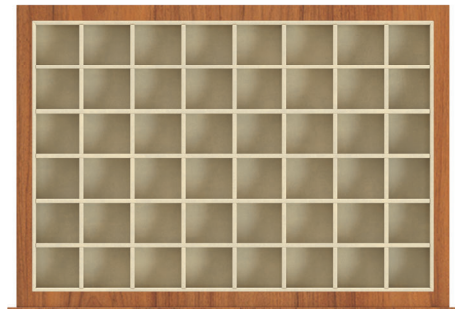

DG6 - SMALL PARTITIONS



DG7- BRACELETS

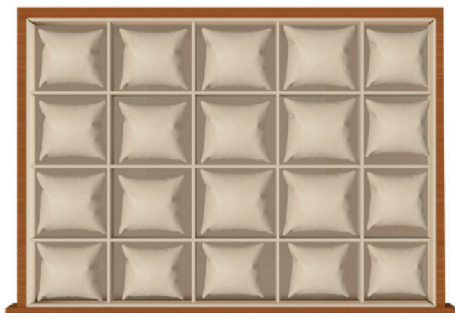

DG8 - WATCHES

WOOD FINISHES FOR DRAWERS



WR1
Rosewood



WE2
Ebony



WO3
Oak

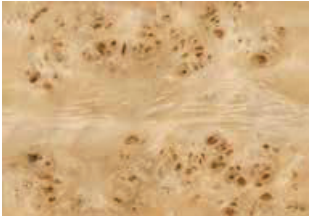

WB4
Burl Eye



WL5
Walnut



WWO6
White Oak

DRAWER INTERIORS



VW001
Off-white



VC001
Cream



VC002
Brown



VW003
Light Blue



VB014
Dark Blue



VR005
Red

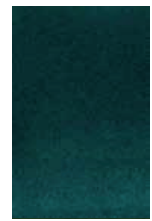

VG007
Green

LEATHER FINISHES FOR CLADDING



LY003
Golden Brown Leather

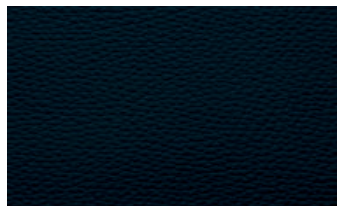

LK001
Black Leather



LB001
Light Taupe Leather



LR001
Red Leather



LG002
Dark Green Leather



LO002
Orange Leather

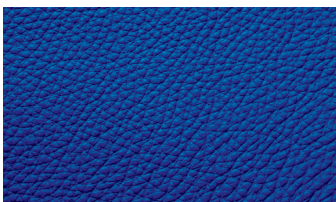

LU001
Blue Leather

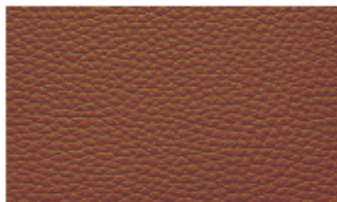

LB001
Brown Leather

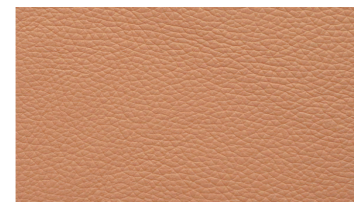

LT001
Tan Leather

STITCH COLOURS FOR LEATHER

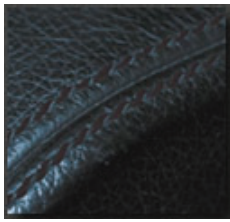

SBI
Black

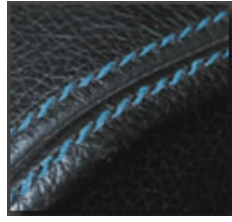

SL2
Light blue

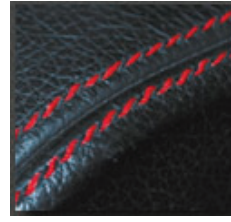

SR3
Red

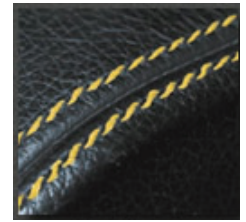

SY4
Yellow

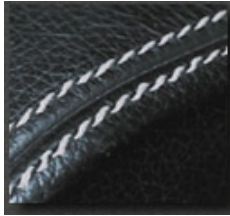

SG5
Grey

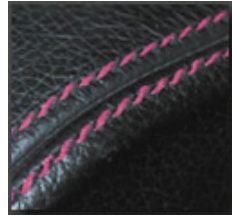

SP6
Pink



SO7
Orange

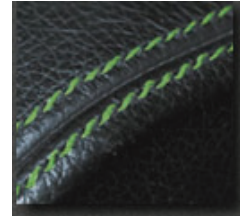

SG8
Green

POSSIBLE COLOURS FOR SAFES



CNB1
Royal Blue



CR2
Red



CB3
Black

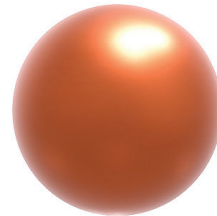

C04
Orange



CG5
Green

DOOR SWING

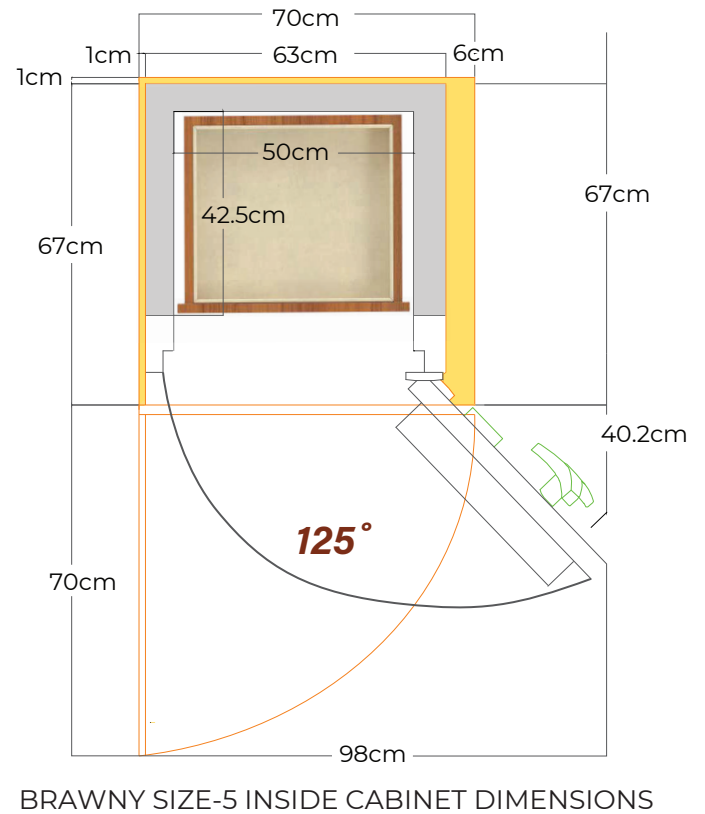
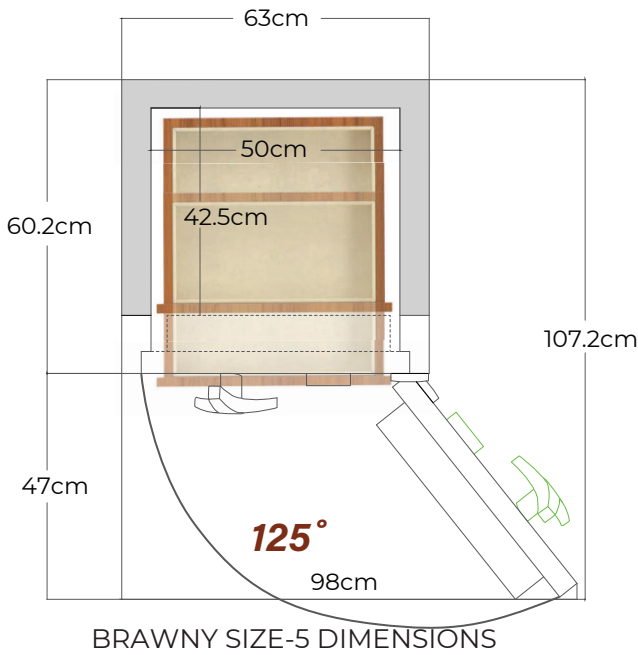

Safe Door Clearance

Our Brawny Luxury safe is designed for seamless integration into wardrobes and cabinetry. For optimal functionality, ensure a 125-degree door opening with the following clearance:

- **98 cm in front for unobstructed door movement**
- **Adequate side clearance to prevent interference**

This opening angle allows effortless access to valuables, including watch winders and jewelry trays.

To ensure a hassle-free installation, our safe experts can visit your site to consult with your contractor and determine the exact dimensions needed for your wardrobe construction. This guarantees a perfect fit and smooth operation once your safe arrives.

Description	Brawny RMK3	Brawny RMK4	Brawny RMK5
Height	75cm	75cm	98cm
Width	50cm	63cm	63cm
Depth	56cm	66cm	66cm
Weight	255kg	341kg	421kg
Number of drawers	8	8	16
Maximum no. of watch winders	3 - 12	4 - 24	24
Gun Drawers	Possible	Possible	Possible
Jewellery Drawers	Possible	Possible	Possible
Fire Resistance	60 mins	60 mins	60 mins

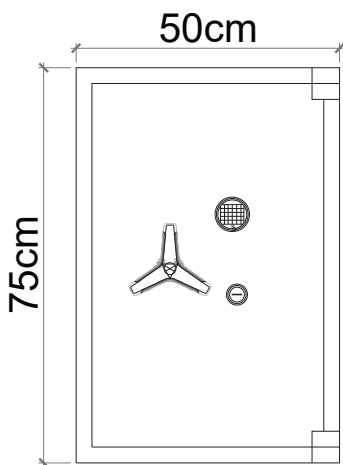

BRAWNY RMK3

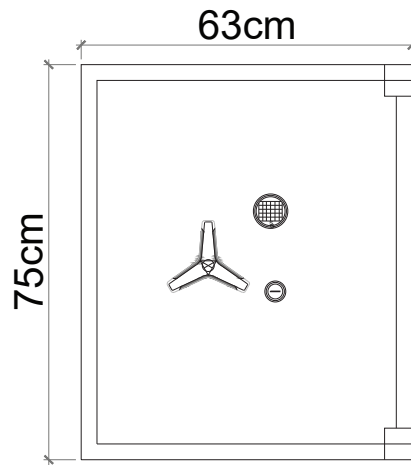

BRAWNY RMK4

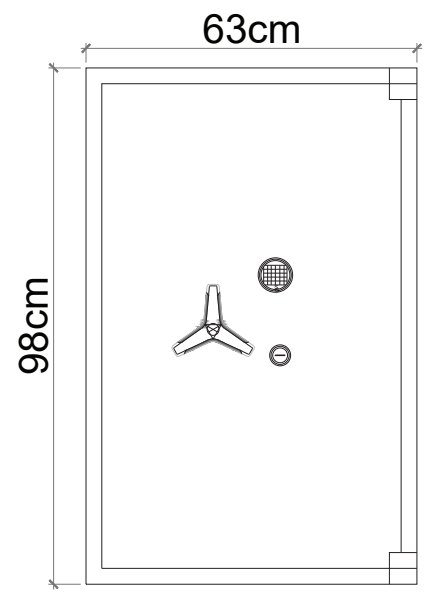

BRAWNY RMK5



KINDLY CONTACT US

+965 6695 5617 www.kaavalkuwait.com thomas@kaavalkuwait.com [@kaavalsecuritysystems](https://www.instagram.com/kaavalsecuritysystems)
[@chubbsafes_kuwait](https://www.instagram.com/chubbsafes_kuwait)

Al Rai, Kuwait, Hassan Abul Complex Block 4, Street 9, Near ACE Hardware, [@chubbsafes_kuwait](https://www.instagram.com/chubbsafes_kuwait)